

SPECIFICATIONS OF

Model **DRS6A-NXT** / Model **DRS4D-NXT**

ANTENNA

**DRS6A-NXT**  
 Slotted waveguide array  
 Vertical beam width 22°  
 Horizontal beam width 2.3° (XN10A), 1.9° (XN12A), 1.4° (XN13A)  
 Antenna rotation speed 24/36/48 rpm range coupled or 24 rpm fixed



**DRS4D-NXT**  
 Radome (24°)  
 Vertical beam width 25°(-3dB)  
 Horizontal beam width 3.9° (-3dB) Adjustable between 2.0° and 3.9° (effective with RezBoost control)  
 Antenna rotation speed 24/36/48 rpm range coupled or 24 rpm fixed (select)



RADAR FUNCTION

Tx frequency 3 channel, auto/manual selectable

Channel	P0N (MHz)	Q0N (MHz)
1	9380	9400
2	9400	9420
3	9420	9440

Output power 25 W

Pulse Length, Pulse Repetition Rate and Range Scales

	DRS6A-NXT	DRS4D-NXT
Range Scales[NM]	0.0625-72	0.0625-36
Pulse length(P0N)[us]	0.04-1.2	0.08-1.2
Pulse length(Q0N)[us]	5-48	5-18
PRR[Hz]	700-2000	1100
Tx frequency[MHz]	9380-9440	

Minimum range DRS6A-NXT: 10 m, DRS4D-NXT: 20 m  
 Range resolution DRS6A-NXT: 10 m, DRS4D-NXT: 20 m  
 Range accuracy 1% of range in use or 10 m, whichever is the greater  
 Bearing accuracy ±1°

INTERFACE

Number of ports LAN: 1 port, Ethernet, 100Base-TX, RJ45  
 Data sentences IEC61162-1/2  
 Input GGA, GLL, GNS, HDG, HDM, HDT, RMA, RMC, THS, VHW, VTG

POWER SUPPLY

DRS6A-NXT: 12/24 VDC: 9.5/5.0 A max.  
 DRS4D-NXT: 12-24 VDC: 2.5-1.3 A

ENVIRONMENT

Ambient temperature -25 °C to +55 °C (storage: -30 °C to +70 °C)  
 Relative humidity DRS6A-NXT: 95% or less at +40 °C  
 DRS4D-NXT: 93% or less at +40 °C  
 Degree of protection DRS6A-NXT: IP56  
 DRS4D-NXT: IP26  
 Vibration IEC 60945 Ed.4

EQUIPMENT LIST

**DRS6A-NXT**  
 Standard Scanner Unit (RSB-137-119), Radiator, Installation Materials, Spare Parts  
 Option LAN cable 2/5/10 m, Joint Box (TL-CAT-012)

**DRS4D-NXT**  
 Standard Radar Sensor (RSB-135-115), Installation Materials, Spare Parts  
 Option Radome Mount (OP03-208), (OP03-239)LAN cable 2/5/10 m, Joint Box (TL-CAT-012)

Antenna Unit

**DRS6A-NXT**  
 XN10A 20 kg 44.1 lb  
 XN12A 21 kg 46.3 lb  
 XN13A 23 kg 50.7 lb

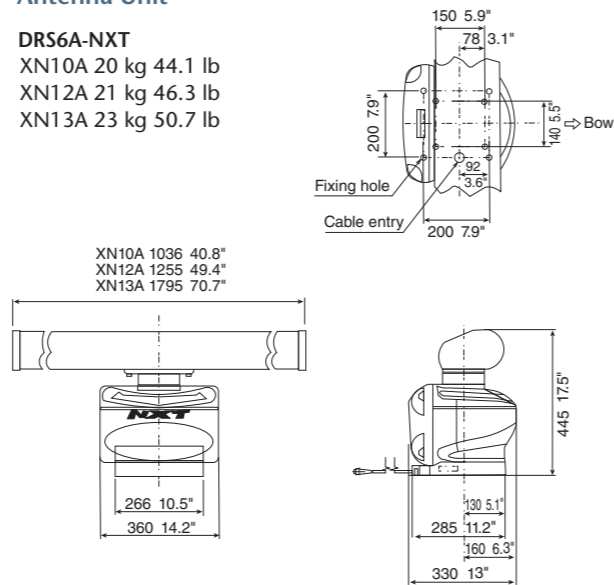

**DRS4D-NXT**

7.3 kg 16.1 lb

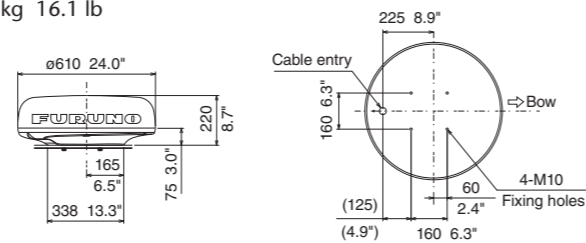

Interconnection Diagram

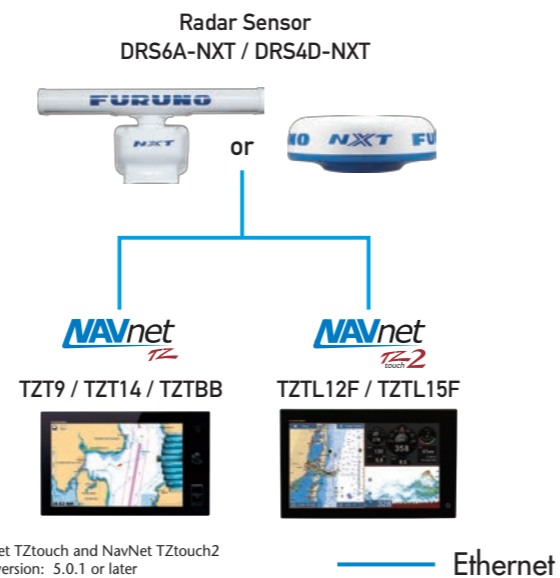

SOLID STATE DOPPLER RADAR

Model **DRS6A-NXT**  
 Model **DRS4D-NXT**

**NEW**



Beware of similar products

All brand and product names are registered trademarks, trademarks or service marks of their respective holders.

SPECIFICATIONS SUBJECT TO CHANGE WITHOUT NOTICE

**FURUNO ELECTRIC CO., LTD.**  
 Japan | www.furuno.com  
**FURUNO U.S.A., INC.**  
 U.S.A. | www.furunousa.com  
**FURUNO PANAMA S.A.**  
 Republic of Panama | www.furuno.com.pa  
**FURUNO (UK) LIMITED**  
 U.K. | www.furuno.co.uk  
**FURUNO NORGE A/S**  
 Norway | www.furuno.no

**FURUNO DANMARK A/S**  
 Denmark | www.furuno.dk  
**FURUNO SVERIGE AB**  
 Sweden | www.furuno.se  
**FURUNO FINLAND OY**  
 Finland | www.furuno.fi  
**FURUNO POLSKA Sp. z o.o.**  
 Poland | www.furuno.pl  
**FURUNO DEUTSCHLAND GmbH**  
 Germany | www.furuno.de

**FURUNO FRANCE S.A.S.**  
 France | www.furuno.fr  
**FURUNO ESPAÑA S.A.**  
 Spain | www.furuno.es  
**FURUNO ITALIA S.R.L.**  
 Italy | www.furuno.it  
**FURUNO HELLAS S.A.**  
 Greece | www.furuno.gr  
**FURUNO (CYPRUS) LTD**  
 Cyprus | www.furuno.com.cy

**FURUNO EURUS LLC**  
 Russian Federation | www.furuno.ru  
**FURUNO SHANGHAI CO., LTD.**  
 China | www.furuno.com/cn  
**FURUNO CHINA CO., LTD.**  
 Hong Kong | www.furuno.com/cn  
**FURUNO SINGAPORE**  
 Singapore | www.furuno.sg

**PT FURUNO ELECTRIC INDONESIA**  
 Indonesia | www.furuno.id

1-A-17083SK  
 Catalogue No. CA000001147



# The **NXT** chapter in Radar technology!

**DRS4D-NXT**  
Radome type

Enhanced analytics and improved detection to keep your journey safe

**DRS6A-NXT**  
Open array type



## Target Analyzer™ function utilizing Doppler technology spots hazardous targets instantly!

The DRS4D-NXT and the DRS6A-NXT are the first radars in the world to use FURUNO's exclusive Target Analyzer™ function. Targets that are approaching your vessel automatically change color to help you identify potentially dangerous targets. Green echoes are targets that stay stationary, or are moving away from you, while red echoes are hazardous targets that are moving towards your vessel. Echoes dynamically change colors as targets approach, or get farther away from your vessel. Target Analyzer™ improves situational awareness and can increase safety by showing you which targets to look out for.

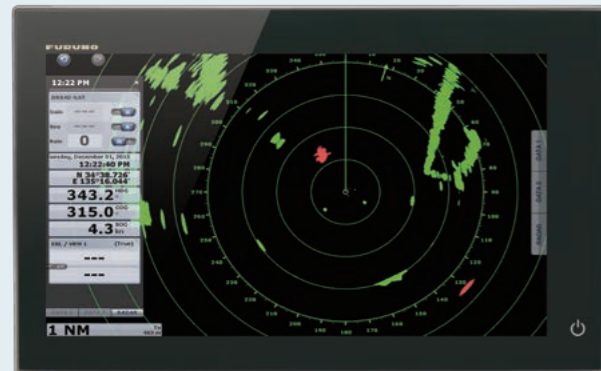

NavNet TZTouch2

On the screen, approaching targets are displayed in red

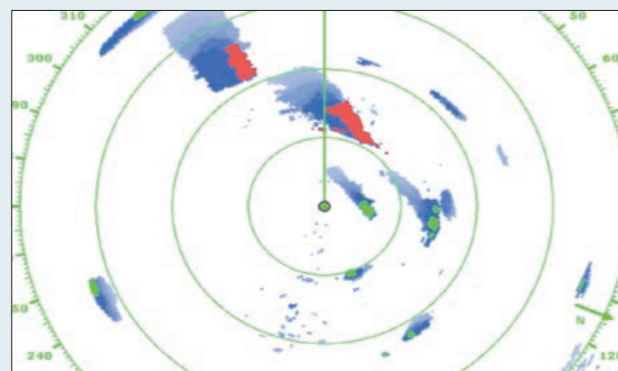

Target Analyzer™ clearly shows both Safe and Hazardous targets (Echo trail activated)

## Fast Target Tracking™ and Auto Target Acquire function

With **Fast Target Tracking™** activated, it only takes a few seconds for a vector to be displayed once the target is selected, manually or automatically with the **Auto Target Acquire function**.

When the **Auto Target Acquire** function is **on**, approaching targets within 3NM range from own ship, which are potentially hazardous, are automatically acquired by Doppler calculation and will trigger an alarm\*.

Together, Up to 100 targets can be acquired simultaneously, increasing considerably the safety and simplifying estimation of other vessel's course and speed.

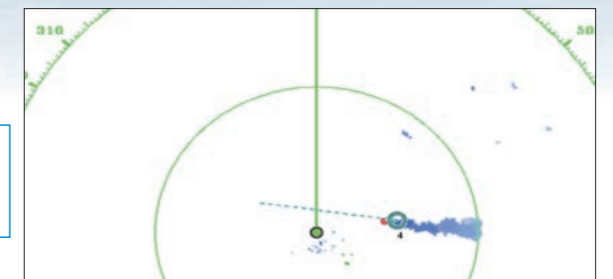

Approaching vessel with target vector and trail

\*TCPA setting required

## RezBoost™ beam sharpening



FURUNO's exclusive RezBoost™ technology has been incorporated into our Radar units for enhanced resolution and impressive performance.

With RezBoost™ set to MAX, the sharpness offers an incredibly detailed image with more targets and less clutter.

(the pictures show images captured by the DRS4D-NXT with Standard RezBoost™ and Max RezBoost™)

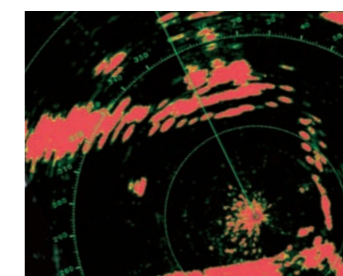

RezBoost™ standard (DRS4D-NXT)

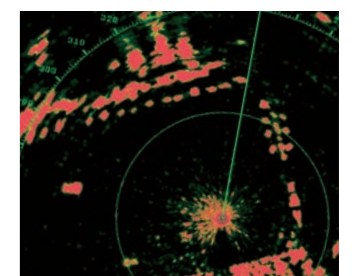

RezBoost™ Enhanced, MAX setting (DRS4D-NXT)

## Bird Mode

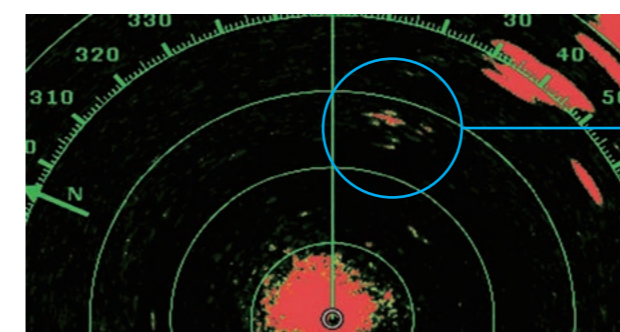

Bird echoes



Actual scene

DRS6A-NXT and DRS4D-NXT feature a new Bird Mode that helps you identify birds gathering around schools of fish at the sea surface. Bird mode adjusts the gain and sea settings automatically for optimal visibility.

### ▶ Solid-State pulse compression Doppler Radar

No preheating time, low energy consumption (no use of a magnetron)

### ▶ Revolutionary Target Analyzer™ function instantly identifies hazardous targets

### ▶ Fast Target Tracking™ and Auto Target Acquire function, up to 100 targets

### ▶ RezBoost™ beam sharpening to increase the resolution

### ▶ High bearing resolution\*

Can reach 0.7° with DRS6A-NXT, and 2.0° with DRS4D-NXT (when using RezBoost™)  
\*the lower the better

### ▶ Bird Mode to find the best fishing grounds by tracking birds

### ▶ Simple installation, no need to open the radome (DRS4D-NXT only), external PSU is not required

### ▶ New smart-connector cable for retrofitting existing DRS cable installations (DRS4D-NXT only)